



FAST RECOVER RECTIFIER

RGP15A THRU RGP15M

VOLTAGE RANGE
CURRENT

50 to 1000Volts
1.5 Ampere

Features

- High temperature metallurgically bonded construction
- Glass passivated cavity-free junction
- 1.5 amperes operation at $T_A = 55^\circ\text{C}$ and with no thermal runaway.
- Typical k_r less than 0.1uA

Maximum Ratings

- Operating Temperature: -55°C to $+150^\circ\text{C}$
- Storage Temperature: -55°C to $+150^\circ\text{C}$
- Typical Thermal Resistance: 45°C/W Junction to Ambient

MCC Part Number	Maximum Recurrent Peak Reverse Voltage	Maximum RMS Voltage	Maximum DC Blocking Voltage
RGP15A	50V	35V	50V
RGP15B	100V	70V	100V
RGP15D	200V	140V	200V
RGP15G	400V	280V	400V
RGP15J	600V	420V	600V
RGP15K	800V	560V	800V
RGP15M	1000V	700V	1000V

DO-15

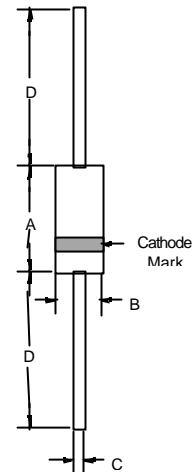

DIM	INCHES		MM		NOTE
	MIN	MAX	MIN	MAX	
A	.230	.300	5.80	7.60	
B	.104	.140	2.60	3.60	
C	.026	.034	.70	.90	
D	1.000	---	25.40	---	

Electrical Characteristics @ 25°C Unless Otherwise Specified

Maximum Average Forward Current	$I_{F(AV)}$	1.5 A	$T_A = 55^\circ\text{C}$
Peak Forward Surge Current	I_{FSM}	50A	8.3ms, half sine
Maximum Instantaneous Forward Voltage	V_F	1.3V	$I_{FM} = 1.5A$; $T_A = 25^\circ\text{C}$
Maximum DC Reverse Current At Rated DC Blocking Voltage	I_R	5.0uA 200uA	$T_A = 25^\circ\text{C}$ $T_A = 150^\circ\text{C}$
Maximum Reverse Recovery Time RGP15A-15G RGP15J RGP15K-15M	T_{rr}	150nS 250nS 500nS	$I_F = 0.5A$, $I_R = 1.0A$, $I_{rr} = 0.25A$
Typical Junction Capacitance	C_J	25pF	Measured at 1.0MHz, $V_R = 4.0V$



FAST RECOVER RECTIFIER

RGP15A THRU RGP15M

VOLTAGE RANGE
CURRENT

50 to 1000Volts
1.5 Ampere

Figure 1
Typical Forward Characteristics

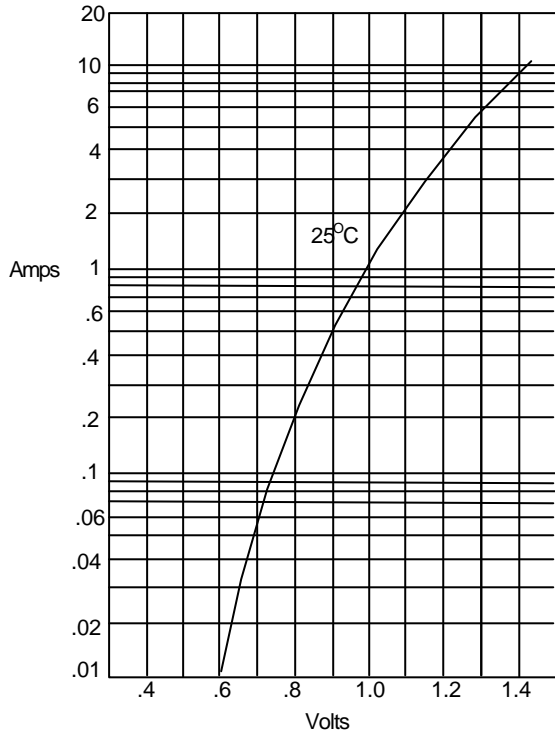

Instantaneous Forward Current - Amperes versus
Instantaneous Forward Voltage - Volts

Figure 2
Forward Derating Curve

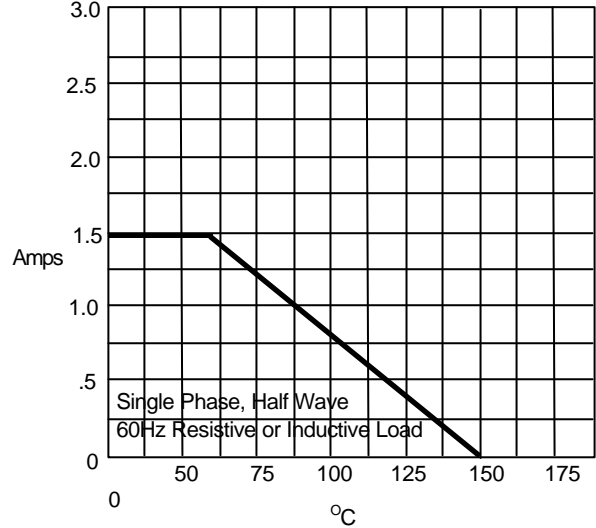

Average Forward Rectified Current - Amperes versus
Ambient Temperature - °C

Figure 3
Junction Capacitance

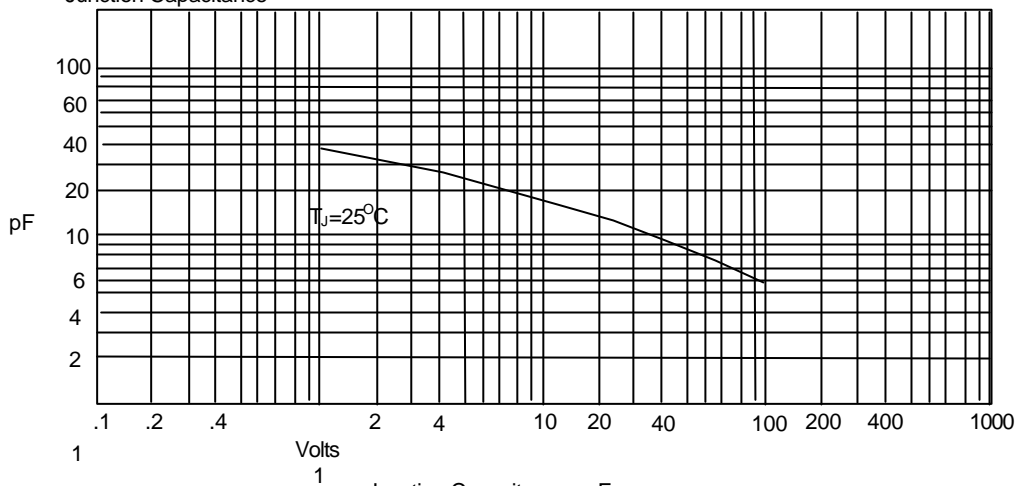

Junction Capacitance - pF versus
Reverse Voltage - Volts

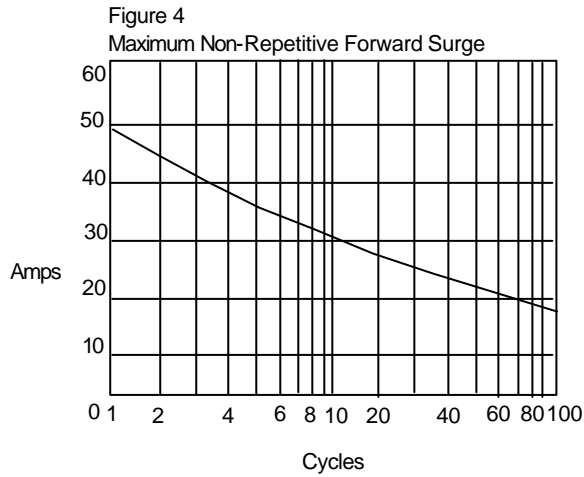

Peak Forward Surge Current - Amperes versus
Number Of Cycles At 60Hz - Cycles

Figure 5
Reverse Recovery Time Characteristic And Test Circuit Diagram

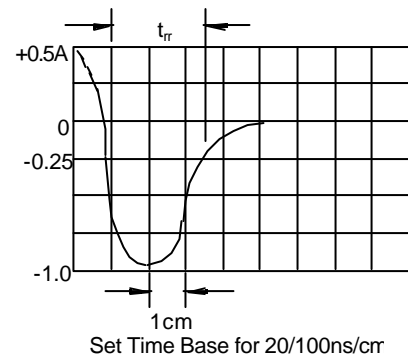
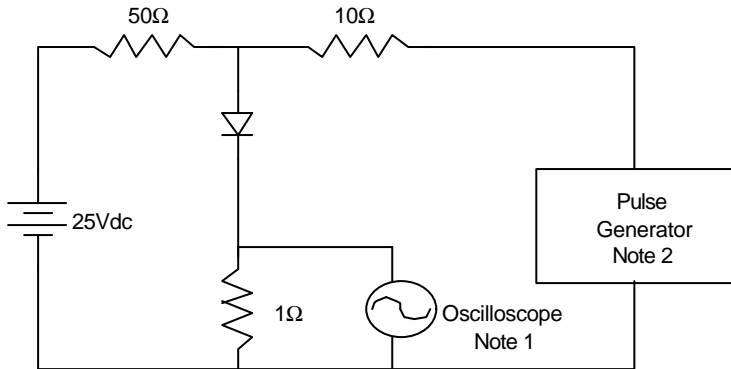

Notes:

1. Rise Time = 7ns max.
Input impedance = 1 megohm, 22pF
2. Rise Time = 10ns max.
Source impedance = 50 ohms
3. Resistors are non-inductive